

USER MANUAL

Line Interactive UPS GT M 1-3kVA



Uninterruptible Power Supply System

IMPORTANT SAFETY INSTRUCTIONS

SAVE THESE INSTRUCTIONS

This manual contains important instructions for 1000VA/1500VA/2000VA/3000VA series that should be followed during installation and maintenance of the UPS and batteries. Please read all safety and operating instructions before operating the UPS. Adhere to all warnings on the unit and in this manual. And follow all operating and user instructions.

CONTENTS

1. Introduction	1
2. Safety Warning	2
2.1 Description of Commonly Used Symbols	3
3. Installation	4
3.1 Inspection of Unit	4
3.2 Unpacking the Cabinet	4
3.3 UPS Setup	4
3.4 EBM Installation (Optional)	9
3.5 UPS Initial Startup	15
4. Operation	16
4.1 Display Panel	16
4.2 Operating Mode	20
4.3 Configuring Load Segment	20
4.4 Configuring UPS for EBM Numbers	21
4.5 Configuring Green Function	21
5. Communication Port	22
5.1 RS-232 and USB Communication Ports	22
5.2 Emergency Power Off (EPO)	22
5.3 Network Management Card (Optional)	23
6. UPS Maintenance	24
6.1 UPS and Battery Care	24
6.2 Storing the UPS and Batteries	24
6.3 Time to Replace Batteries	24
6.4 Replacing UPS Internal Batteries	25
6.5 Testing New Batteries	27
6.6 Recycling the Used Battery:	27
7. Specification	28
7.1 Specification	28
7.2 Rear Panels	30
8. Trouble Shooting	33
8.1 Audible Alarm Trouble Shooting	33
8.2 General Trouble Shooting	33
9. Software Installation	34

1. Introduction

This line-interactive series is compact and pure sine wave UPS and it is designed for essential applications and environment, such as desktops, servers, workstations, and other networking equipments. These models are available in the output ratings of 1000VA, 1500VA, 2000VA and 3000VA. The series protects your sensitive electronic equipments against power problems including power sags, spike, brownouts, line noise and blackouts.

The series is convertible to rack and tower forms. It can be placed either in Rack 2U or Tower form. The front panel of the UPS includes LCD display and four control buttons that allow users to monitor, configure and control the units. On LCD, it also includes a LCD graphical bar, two status indications and four alarm indications. A control button from the front panel allows users to silence off the AC fail alarm and initiate the UPS self test sequence as well. The UPS case for 1000VA ~ 3000VA is made of metal. This series is powered from the AC mains and supply AC outputs via receptacles on the rear panel. Communication and control of UPS is available through serial or USB ports located on the rear panel. The serial port will support communications directly with a server.

Features:

- Microprocessor control guarantees high reliability
- High frequency design
- Built-in boost and buck AVR
- Easy battery replacement design
- Selectable input and output range
- Cold start capability
- Built-in Dry contact/RS-232/USB communication port
- SNMP allows for web-based remote or monitoring management
- Enable to extend runtime with scalable external battery module(EBM)
- Overload, short-circuit, and overheat protection
- Rack/Tower 2 in 1 Design
- 19 inches rack mount available for all models

2. Safety Warning



DANGER:

This UPS contains high voltages. All repairs and service should be performed by authorized service personnel only. There are no user serviceable parts inside the UPS.



WARNING:

- This UPS contains its own energy source (batteries). The UPS output may carry live voltage even when the UPS is not connected to an AC supply.
- To reduce the risk of fire or electric shock, install this UPS in a temperature and humidity controlled, indoor environment, free of conductive contaminants. (Ambient :0-40°C)
- To reduce the risk of fire, connect to a circuit breaker provided with 20 amperes maximum branch circuit over-current protection.
- To comply with international standards and wiring regulations, the sum of the leakage currents of the UPS and the connected loads must not exceed 3.5mA.
- The socket outlet that supplies the UPS shall be installed near the UPS and shall be easily accessible.
- Protective earthing connections shall be such that disconnection of a protective earth should be made at one point that is the furthest away from the UPS, maintaining the dedicated line in order to secure equipotential connection.
- The UPS and EBMs connected in series should be installed closely such that the operators can not touch the interconnecting wire which is basic insulated from primary circuit.



CAUTION:

- Batteries can present a risk of electrical shock or burnt from high short-circuit current. Observe proper precautions. Servicing should be performed by qualified service personnel knowledgeable of batteries and required precautions. Keep unauthorized personnel away from batteries.
- Proper disposal of batteries is required. Refer to your local codes for disposal requirements.
- Never dispose of batteries in a fire. Batteries may explode when exposed to flame.



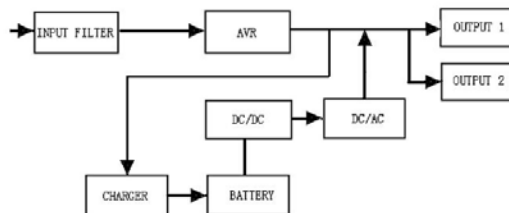



Following figure shows the basic internal circuit configuration of the UPS



2.1 Description of Commonly Used Symbols

Some or all of the following Notations may be used in this manual and may appear in your application process. Therefore, all users should be familiar with them and understand their explanations.

Table1. Description of Commonly Used Symbols

Symbol	Description
	Alert you to pay special attention
	Caution of high voltage
	Alternating current source (AC)
	Direct current source(DC)
	Protective ground
	Recycle
	Keep UPS in a clear area

3. Installation

3.1 Inspection of Unit

Inspect the UPS upon receiving. If the UPS is apparently damaged during the shipment, please keep the box and packing material in original form for the carrier and notify the carrier and dealer immediately.

3.2 Unpacking the Cabinet

To unpack the system:

1. Open the outer carton and remove the accessories packaged with the cabinet.
2. Carefully lift the cabinet out of the outer carton and set it on a flat, stable surface.
3. Discard or recycle the packaging in a responsible manner, or store it for future use.

3.3 UPS Setup

All model series are designed for tower and rack purpose. They can be installed into a 19 inches equipment rack. Please follow the instruction for Tower Setup and Rack-Mount Setup.

● Tower setup

This series of UPS can be placed horizontally and vertically. As a tower configuration, it is provided with the optional UPS stands to stabilize the UPS when the UPS is positioned in vertical. The UPS stand must be attached to the bottom of the tower.

Use the following procedure to install UPS in UPS stands.

1. Slide down the UPS vertically and put two UPS stands at the end of the tower.

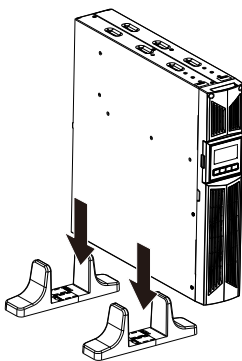

2. Place down the UPS into two stands carefully.

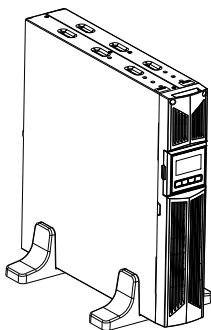

3. Pull out the LCD box and rotate it in a clockwise direction to 90 degree and then push it back in the front panel.

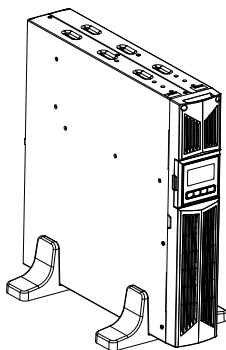
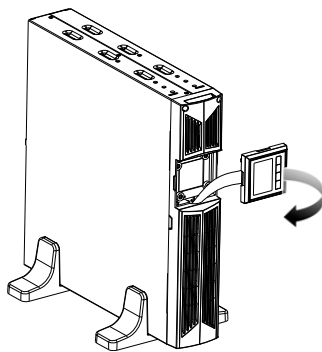

- **Rack-mount setup**

The series can be installed in 19 inches racks. Both the UPS and external battery enclosure need 2U of valuable rack space.

Use the following procedure to install UPS in a rack.

1. Align the mounting ears with screw holes on the side of the UPS, and tighten the screw.

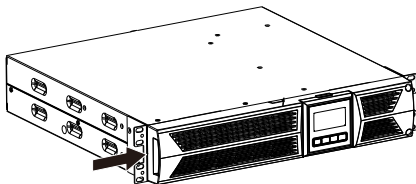

2. Assemble the rack rails with the rack-mounting.

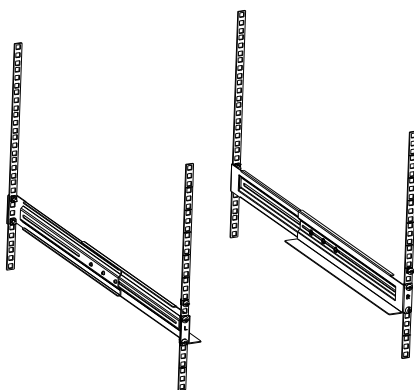

3. Slide in the UPS into the rack rail and lock it in the rack enclosure.

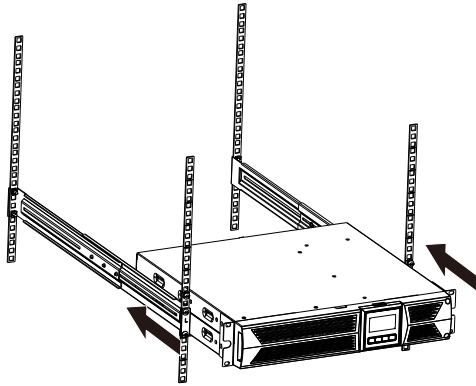

4. Tighten the screw, and the load can then be connected.

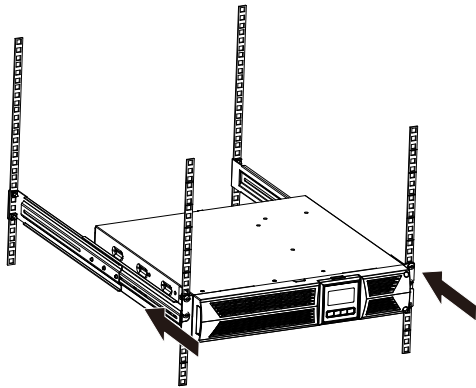

3.4 EBM Installation (Optional)

- **Connecting the EBM in Tower form:**

1. Slide down the UPS and EBM vertically and place two UPS stands with the extend part at the end of the tower.
2. Tighten the screw on the metal sheet for stabilization

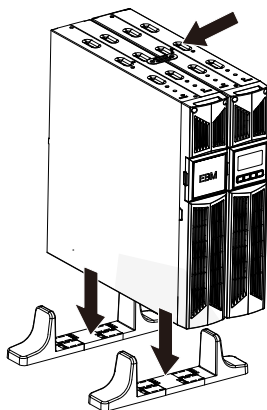

3. Connect the Earth line from UPS (port A) to EBM (port B)

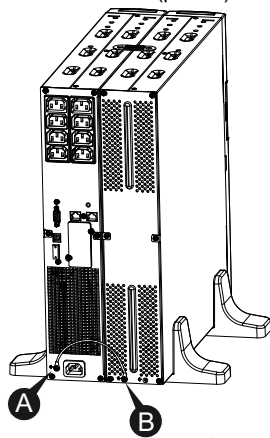

4. Take off the front panel, and connect the battery terminal (A) from UPS to EBM terminal (B) shown as below. Users need to remove the small gate(C) on side of the front panel to allow the outlet wire of the EBM to pass through the gate and then reassemble front panel.

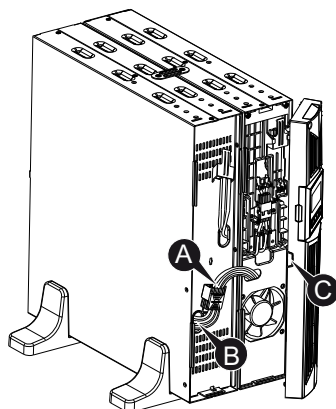

- **Connecting the EBM in a rack form**

1. Using the same method as assembling UPS in a rack form, assemble EBM into the rack-mounting on the top or bottom of the UPS.

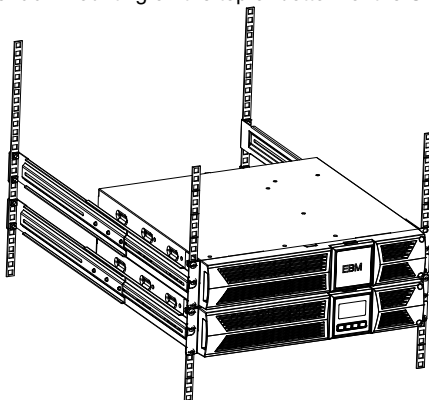

2. Connect the earth line from UPS (port A) to EBM (port B)

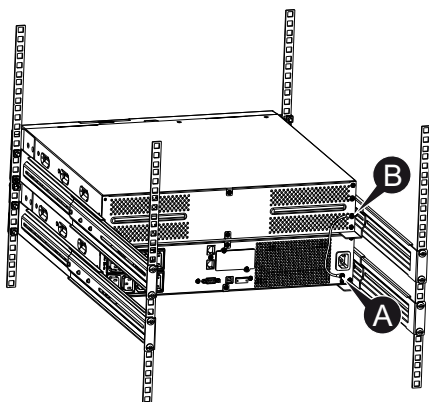

3. Take off the LCD box, and unscrew the internal screws.

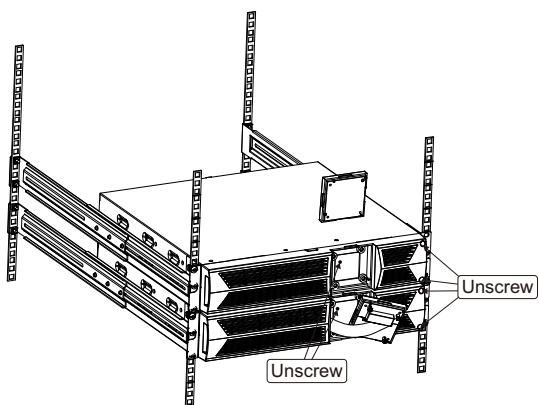

4. Take off the front panel, and connect the battery terminal (A) from UPS to EBM terminal (B) shown as below. Users need to remove the small gate(C) on side of the front panel to allow the outlet wire of the EBM to pass through the gate and then reassemble front panel.

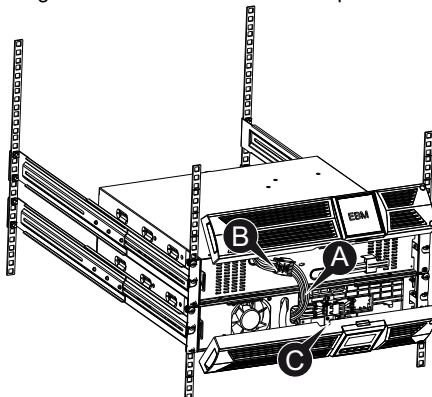

5. After installing the UPS into rack, the load can then be connected to UPS. Please make sure the load equipment is turned off before plugging all loads into the output receptacle.

- **Connecting the Multiple EBMs**

1000VA/1500VA/2000VA and 3000VA UPS include external battery port that allows users to connect multiple EBM in order to provide additional backup time. Follow the procedure to install multiple EBM as below.

Connecting multiple EBMs in Tower form

1. Connect Earth line between UPS and the first EBM, and then connect Earth Line between the first EBM and the second EBM.

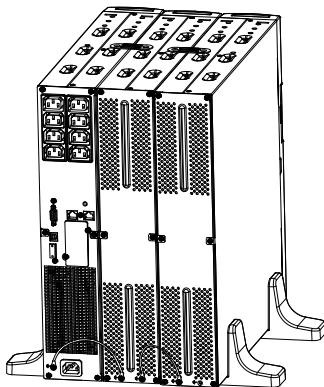

2. Take off the front panel, and connect the battery terminal (A) from UPS to EBM terminal (B) shown as below. And then connect the battery terminal (D) from the first EBM to the battery terminal (E) from the second EBM. Users need to remove the small gate(C) on side of the front panel to allow the outlet wire of the EBM to pass through the gate and then reassemble front panel.

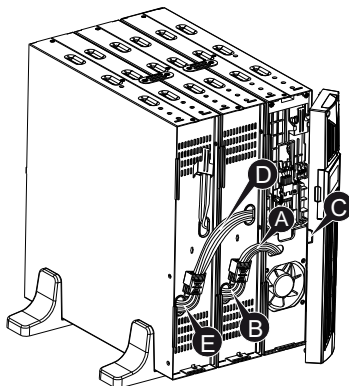

Connecting the Multiple EBMs in rack form

1. Connect Earth line between UPS and the first EBM, and then connect Earth Line between the first EBM and the second EBM.

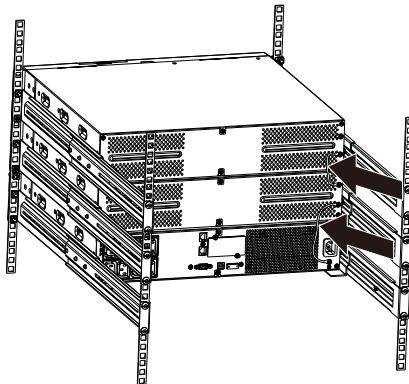

2. Take off the front panel, and connect the battery terminal (A) from UPS to EBM terminal (B) shown as below. And then connect the battery terminal (D) from the first EBM to the battery terminal (E) from the second EBM. Users need to remove the small gate(C) on side of the front panel to allow the outlet wire of the EBM to pass through the gate and then reassemble front panel.

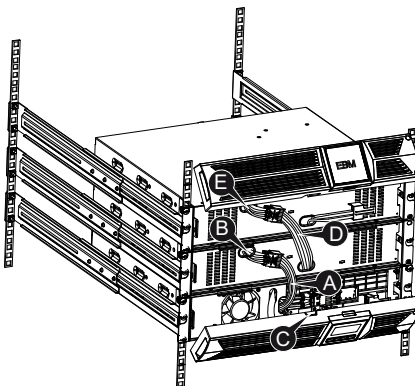

Note: Three or more EBMs can be connected to the UPS in the same way as shown above.

3.5 UPS Initial Startup

To start up the UPS:

1. Verify that the internal batteries are connected. If optional EBMs are installed, verify that the EBMs are connected to the UPS.
2. Plug the equipment to be protected onto the UPS, but do not turn on the protected equipment.
3. Plug in the UPS input power cord. The UPS front panel display illuminates and UPS status display shows "STbY"
4. Press and hold the button  more than 3 seconds. The UPS status display changes to "NORM"
6. Check the UPS display for active alarms or notices. Resolve any active alarms before continuing. See "Troubleshooting"
8. If optional EBMs are installed, see "Configuring UPS for EBM numbers" on page 21 to set the number of installed EBMs.
9. To change any other factory-set defaults, see "Operation"

Note: At initial startup, the UPS sets system frequency according to input line frequency.

4. Operation

4.1 Display Panel

The UPS has a four-button graphical LCD with dual color backlight. Standard back-light is used to light up the display with black text and a blue background. When the UPS has a critical alarm, the backlight changes the background to red. See Figure below:

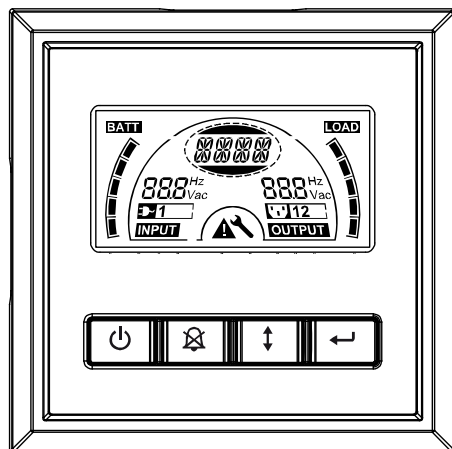

- **Control Buttons functions:**

There are four buttons on the control panel.

 ON/OFF















 UPS Test /Alarm Silence

 Select

 Enter

The following table describes the functions of the LCD control buttons.

Table2. Description of control button

Control Button	Switch	Function
	ON/OFF	<p>--To turn on/off the UPS Press and hold the button  more than 3 seconds.</p> <p>--To release the UPS from faulty mode Cut off input power and then press and hold the button  more than 2 seconds to shut down the UPS.</p>
	UPS Test Alarm Silence	<p>--To perform basic function test Press and hold the button  for 3 seconds.</p> <p>--To perform Battery life test Press and hold the button  for 10 seconds.</p> <p>-- To disable alarm buzzer Press the button  for one second.</p>
	Select	Press the Select button  to select the settings value one by one
	Enter	<p>-- Enter settings mode Press and hold the button  more than 3 seconds.</p> <p>-- Enter settings item Press and hold the Enter button  more than one second, the UPS allows users to configure the settings, and the settings string will flash.</p> <p>-- Confirm settings Press and hold the Enter button  for one second.</p> <p>-- Exit Settings mode Press and hold the Enter button  for 3 seconds or button  for 0.5 second.</p>

Note: Ensure the battery is fully charged during line mode when conducting functional tests.









Note: A list of events shown as below is not able to disable alarm buzzer:
Low Battery, Fan Failed, Fan Fault Time Out, and Overheat.

Note: User can disable the alarm buzzer when it's sounding, but an alarm will still sound when a new alarm event is encountered.

- **LCD display functions:**

The following table describes the functions of the LCD display.

Table3. Description of LCD display function

No.	Description	Function
	Input frequency and voltage	Indicate the value of input frequency and voltage
	Input plug indicator	Light on when the input power is at no loss.
	Output frequency and voltage	Indicate the value of output frequency and voltage
	Output plug indicator	The UPS has two groups of outlets. The output plug indicator will light on if there is output power respectively.
	UPS status/user setting display String	Strings Indicate the UPS status(see Table 4) Strings Indicate user setting options(see Table 5)
	Warning indication	Light on when the UPS is failure or alarm.
	Settings	Light on when the UPS under settings mode.
	Battery volume level display	Indicate the amount of battery volume remaining. Each battery volume level bar indicates a 20% of total battery volume
	Load capacity level display	Indicate the percentage of UPS load capacity which is being used by the protected equipment. Each LCD level bar indicates a 20% of the total UPS output capacity.

- **UPS Status Display String Description:**

The following table shows the description of the LCD display string:

Table4. UPS Status Display String

LCD Display String	Description
STbY	UPS work at Standby mode
IPVL	Input voltage is too low
IPVH	Input voltage is too high
IPFL	Input frequency is too low
IPFH	Input frequency is too high
NORM	UPS work at Line mode
AVR	UPS work at AVR mode
bATT	UPS work at Battery mode
TEST	UPS work at battery life/function test mode
OPVH	Battery mode, the output is too high
OPVL	Battery mode, the output is too low
OPST	Output short
OVLD	Overload
bATH	Battery voltage is too high
bATL	Battery voltage is too low
OVTP	Internal temperature is too high
FNLK	Fan is locked
bTWK	Batteries are weak

- **User Setting String Description:**

The following table shows the options that can be changed by user.

Table5. User Setting String

OPV	Output voltage mode select	[220]= 220V [230]= 230V [240]= 240V
AVR	Input type select	[000]= Normal range mode [001]= Wide range mode [002]= Generator mode
EbM	External battery module (EBM)	0~9 is the number of external battery module
TEST	Auto self-test	[000]=Disable [001]=Enable
AR	Automatic restart	[000]=Disable [001]=Enable
GF	Green function	[000]=Disable [001]=Enable
bZ	Buzzer control	[000]=Disable [001]=Enable
LS1	Load segment 1	[000]=Turn off [001]=Turn on
LS2	Load segment 2	[000]=Turn off [001]=Turn on

4.2 Operating Mode

- Normal range mode: Under Input mode the UPS accepts AC input voltage range for +/-20%.
- Generator mode: Under generator mode, the low frequency transfer point can go as low as 40Hz and as high as 70Hz before being transferred to battery mode.
- Wide range mode: Under Input settings mode, the UPS accepts AC input voltage range for -30% ~ +20%.
- Battery mode

When the UPS is operating during a power outage, the alarm beeps once every four seconds and the LCD display string shows "bATT" to indicate the UPS work at battery mode.

If battery volume becomes low while in Battery mode, the alarm beeps once every second and the LCD display string shows "bATL".

- Standby mode





When the UPS is turned off and remains plugged into a power outlet, the UPS is on Standby mode. The LCD display string shows "STbY" to indicate that power is not available to your equipment. The battery recharges when necessary.



4.3 Configuring Load Segment

Load segment are sets of receptacles that can be controlled through the display. Each UPS has two configurable load segments. See "Rear Panels" on page 30 for load segment for each UPS model.

Note: This configuring can be operated when UPS is power on.







To configure the load segment through the display:

1. **Enter settings mode:** Press and hold the Enter button  more than 3 seconds. Then UPS will transfer to setting mode.
2. **Select settings items:** Press the Select button  to select the setting items show as Table 5.
3. **Enter settings item:** When the LCD display "LS1" or "LS2", press the enter button  more than one second to enter the setting item and the settings string will flash.
4. **Select setting value:** Press the Select button  to select the settings value. Select the value [001] or [000] to set the desired load segment ON or OFF.
5. **Confirm settings:** Press and hold the Enter button  for one second, ups will return to current setting item.

6. **Exit Settings mode:** Press and hold the Enter button  for 3 seconds or button  for 0.5 second to exit setting mode.

4.4 Configuring UPS for EBM Numbers







To ensure the LCD displays the correct battery volume, configure the UPS for the correct number of EBMs:

1. **Enter settings mode:** Press  more than 3 seconds to enter setting mode.
2. **Select settings items:** Press  to select setting items as "EBM".
3. **Enter settings item:** Press  more than one second to enter the setting item.
4. **Select setting value:** Press the Select button  to select the number of EBM according to your UPS configuration.
5. **Confirm settings:** Press and hold the Enter button  one second, ups will return to current setting item.
6. **Exit Settings mode:** Press and hold the Enter button  for 3 seconds or button  for 0.5 second to exit setting mode.

4.5 Configuring Green Function

Green Function is that when an insignificant amount of load is detected, the UPS will shut down output automatically on battery mode.

The green function is disabled on default mode and user can configure Green Function through the display:

1. **Enter settings mode:** Press  more than 3 seconds to enter setting mode.
2. **Select settings items:** Press  to select setting items as "GF".
3. **Enter settings item:** Press  more than one second to enter the setting item.
4. **Select setting value:** Press the Select button  to select "001".
5. **Confirm settings:** Press and hold the Enter button  for one second, ups will return to current setting item.
6. **Exit Settings mode:** Press and hold the Enter button  for 3 seconds or button  for 0.5 second to exit setting mode.

5. Communication Port

5.1 RS-232 and USB Communication Ports

To establish communication between the UPS and a computer, connect your computer to one of the UPS communication ports using an appropriate communication cable.

When the communication cable is installed, power management software can exchange data with the UPS. The software polls the UPS for detailed information on the status of the power environment. If a power emergency occurs, the software initiates the saving of all data and an orderly shutdown of the equipment.

The cable pins for the RS-232 communication port are identified as below, and the pin functions are described in Table 6.

Table6. DB9 Female (RS232 +dry contact)

PIN #	Description	I/O	Function Explanation
1	BATLOW	Output	Battery low
2	RXD	input	RXD
3	TXD	Output	TXD
4	DTR	Input	N/A
5	Common	--	Common (tied to chassis)
6	DTR	Input	N/A
7	RING	Output	Ring
8	LNFAIL1	Output	Line fail

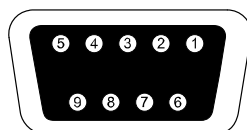

RS232 Communication Port

5.2 Emergency Power Off (EPO)

EPO is used to shut down the load from a distance. This feature can be used for shutting down the load on Emergency.



Warning:

This circuit must be separated from hazardous voltage circuits by reinforced insulation.

**Caution:**

The EPO must not be connected to any utility connected circuits. Reinforced insulation to the utility is required. The EPO Switch must have a minimum rating of 24Vdc and 20mA and be a dedicated latching-type switch not tied into any other circuit. The EPO signal must remain active for at least 20ms for proper operation

EPO Connections		
Wire Function	Terminal Wire Size Rating	Suggested Wire Size
EPO	4-0.32mm ² (12-22AWG)	0.82mm ² (18AWG)

Note: Leave the EPO connector installed in the EPO port on the UPS even if the EPO function is not need.

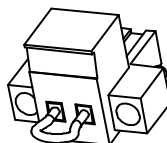

EPO Connector

5.3 Network Management Card (Optional)

Network Management Card allows the UPS to communicate in a variety of networking environments and with different types of devices. The series UPS has one available communication slot for Webpower or other optional card to achieve remote management of the UPS through internet/ intranet. Please contact your local dealer for further information.

6. UPS Maintenance

6.1 UPS and Battery Care

For the best preventive maintenance, keep the area around the UPS clean and dust-free. If the atmosphere is very dusty, clean the outside of the system with a vacuum cleaner. For long battery life, keep the UPS at an ambient temperature of 25°C (77°F)

6.2 Storing the UPS and Batteries

When the UPS is intended to store for a long period, recharge the battery every 6 months by connecting the UPS to utility power. The batteries charge to 90% capacity in approximately 4 hours. However, it is recommended that the batteries charge for 48 hours after long-term storage.

6.3 Time to Replace Batteries

When LCD backlight turns to red, the screen displays "bTWK" and there is a continuous sounding, the battery may need to be replaced. Please check the battery connection or contact your local dealer to order new battery.



WARNING:

- Turn off the UPS and disconnect the utility power cord from the wall outlet.
- Servicing should be performed by qualified service personnel knowledgeable of batteries and required precautions. Keep unauthorized personnel away from batteries
- Batteries can present a risk of electrical shock or burn from high short circuit current. The following precautions should be observed:
 1. Remove watches, rings, or other metal objects.
 2. Use tools with insulated handles.
 3. Do not lay tools or metal parts on top of batteries.
 4. Wear rubber gloves and boots.
 5. Disconnect the charging source prior to connecting or disconnecting battery terminal.
- When replacing batteries, replace with the same type and number of batteries or battery packs. Contact your service representative to order new batteries.

- Do not dispose of battery in a fire. Batteries may explode when exposed to flame.
- Proper disposal of batteries is required. Refer to your local codes for disposal requirements.
- Do not open or mutilate the battery. Released toxic electrolyte is harmful to skin and eyes.

Note: If you are not qualified service personnel to replace the battery, do not attempt to open the battery cabin. Please call local dealer or distributor immediately.

6.4 Replacing UPS Internal Batteries

Follow the steps and Charts as below to replace batteries:

1. Take off the LCD box, and remove the screws.

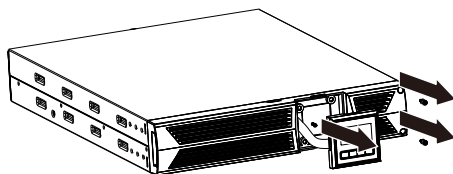

2. Slide and Pull the front panel leftward and then take it off.

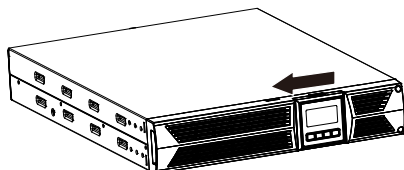

3. Disconnect the cable from the UPS and battery pack.

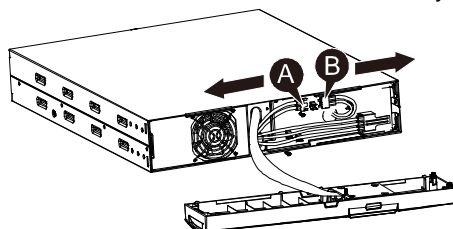

4. Remove the right inner battery bracket.

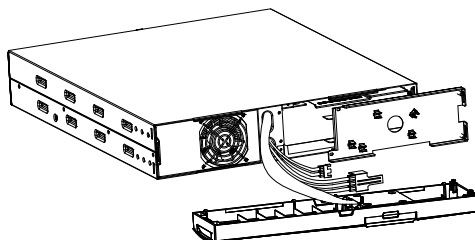

5. Pull the battery pack out onto flat area.

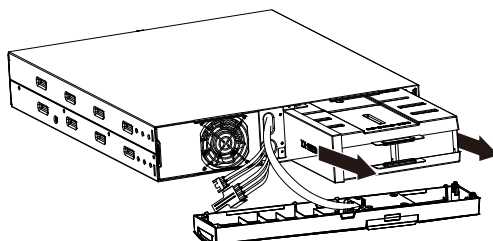

6. Install new battery pack into UPS.

7. Screw up the battery bracket and reconnect the battery cable A and B

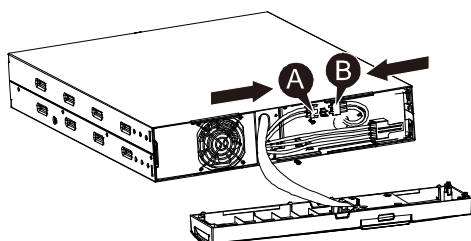

8. Re-install the front panel back to UPS.

6.5 Testing New Batteries

For a battery test, please check:

- The batteries must be fully charged.
- The UPS must be in Normal mode with no active alarms.
- Don't take on/off the load.

To test batteries:

1. Connect the UPS to utility power for at least 48 hours to charge the batteries.
2. Press and hold the  button 10 seconds to start the battery test. The status display string shows "TEST"

6.6 Recycling the Used Battery:



Warning:

- Never dispose the batteries in a fire. It may explode.
- Do not open or mutilate the batteries. Released electrolyte is harmful to the skins and eyes. It may be toxic. A battery can present a risk of electrical shock and high short circuit current.

To recycle properly the used battery, please do not discard the UPS, battery pack and batteries into the trash bin. Please follow your local laws and regulations; you may contact your local recycling waste management center for further information to dispose properly of the used UPS, battery pack, and batteries.

7. Specification

7.1 Specification

Table7. Electrical Specification

Model		1000 1000S	1500 1500S	2000 2000S	3000 3000S
Capacity	Watt	900W	1350W	1800W	2700W
Input	Input voltage range	161-276VAC			
	Frequency range	50/60Hz \pm 5Hz for Normal Mode 40-70Hz for Generator Mode			
Output	Voltage	220/230/240VAC			
	Voltage Regulation (Batt. Mode)	\pm 5%			
	Frequency	50Hz or 60Hz			
	Waveform	Pure sinewave			
Overload rating	Line Mode	110% -0%, +8%: shutdown after 3 minutes. 150% -0%, +10%: shutdown after about 200ms			
	Battery Mode	110% \pm 6%; shutdown after 30 seconds. 120 % \pm 6 %; Shutdown after about 100ms			
Internal battery	Battery Type	12V/7AH	12V/9AH	12V/7AH	12V/9AH
	Backup Time (at full load)	4'30"	3'	4'30"	3'
	Recharge Time	3 hours to 90% after discharged	4 hours to 90% after discharged	3 hours to 90% after discharged	4 hours to 90% after discharged
External battery module(EBM)	Battery Type	12V/7AH			
Interface	RS-232	Optional			
	Dry-Contact	Optional			
	USB	Optional			
	SNMP	Optional			
	EPO	Optional			

Table8. Indicators and Audible alarm

Indicator	AC Mode	NORM---normal mode
	Backup Mode	Show "bATT" and sounding every 4 seconds
	Load/Battery Level	LCD showing
	UPS Fault	LCD show red screen and " **** "
	Overload	LCD show red screen and " OVLD "
	Low Battery	LCD show red screen and " bTLW "
Audible alarm	Backup Mode	Sounding every 4seconds
	Low Battery	Sounding every second
	UPS Fault	Continuously Sounding
	Overload	Sounding every second
	Battery Replacement	Sounding every second

Table9. Operating Environment

Temperature	0 to 40°C
Humidity	20%-80% relative humidity (non-condensing)
Altitude	<1500m
Storage Temperature	-15° to 45° C

Table10. Dimensions and weights

Model		1000	1000S	1500	1500S	2000	2000S	3000	3000S
UPS Case	Net weight (kg)	17.8	10	17.8	10	27.8	16	27.8	16
	Dimension (mm) (W x H x D)	438X86.5x436				438X86.5x608			
EBM Case	Dimension (mm) (W x H x D)	438X86.5x436				438X86.5x608			
	Net weight (kg)	20.5				33.3			

7.2 Rear Panels

The UPS rear panel description table and pictures are shown as below:

No.	Function(1000VA &1500VA)
1	AC Output
2	Modem/Network Surge Protection
3	SNMP Port
4	AC Input
5	RS232 / Dry-Contact Communication Port
6	USB Port
7	EPO
8	Earth Line Port

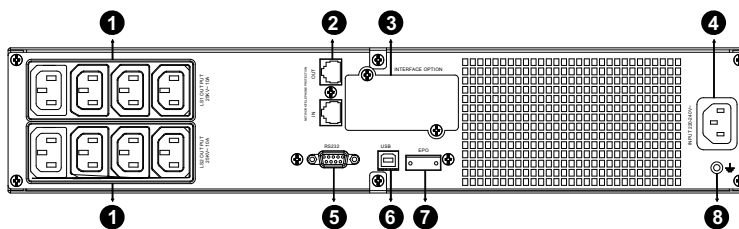

1000VA &1500VA Standard & Super charger model rear panel

No.	Function(2K/3KVA Standard & Supper charger model)
1	AC Output
2	Modem/Network Surge Protection
3	SNMP Port
4	Fan
5	AC Input
6	RS232 / Dry-Contact Communication Port
7	USB Port
8	EPO
9	Earth Line Port

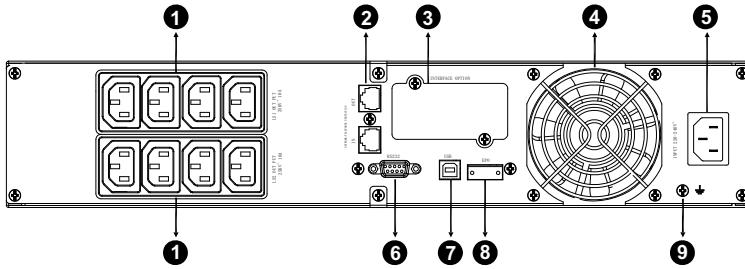

2000VA Standard model rear panel

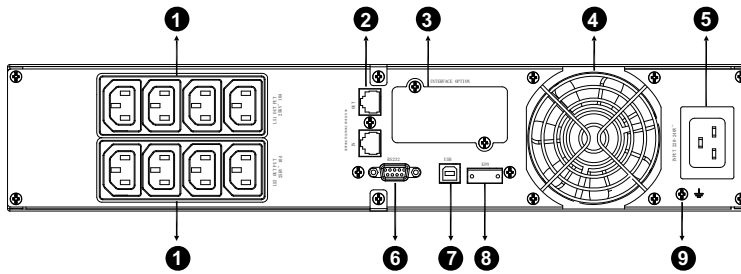

2000VA Super charger model rear panel

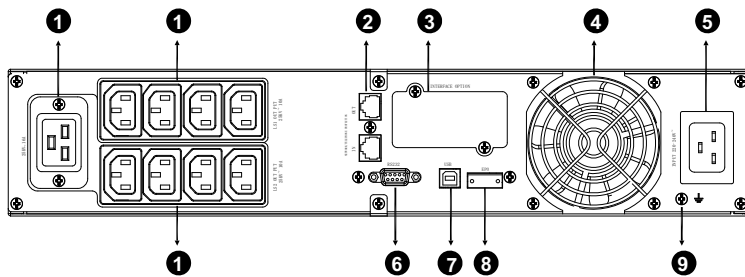

3000VA Standard & Super charger model rear panel

The EBM rear panel description table and picture are shown as below:

No.	Function(36V &72V EBM)
1	Earth Line Port

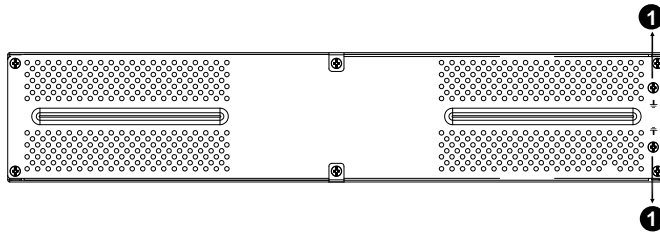

36V &72V EBM rear panel

8. Trouble Shooting

8.1 Audible Alarm Trouble Shooting

Indication	Cause	Solution
Sounding every 4 seconds	The UPS is on battery mode	Check the input voltage
Sounding every Second and "bATL" on screen	The battery voltage is low	Save your work and turn off your equipment
Sounding every second and "OVLD" on screen	Output overload	Check load level indicator and remove some load
Continuously sounding and red display	The UPS fails	Please contact your local dealer

8.2 General Trouble Shooting

Problem	Cause	Solution
The UPS can't be turned on when power switch is pressed	Internal fuse may be broken	Please contact your local dealer
UPS is on and no power to load	Output Jumpers is not connected correctly	Check output Jumpers
	No power on output receptacle	Check if the LS1 and LS2 are set up from "001 to 000".
Backup time is short	Battery is empty	Re-charge the battery at least 24 hours
	Battery aging	Replace Battery
Continuously sounding and display turn to red	The UPS fails	Please contact your local dealer
Buttons does not work	The setting mode is not a right path	please see right configuring method
	Button is Broken	Please contact your local dealer

9. Software Installation

Winpower is UPS monitoring software, featuring user-friendly interface to monitor and control your UPS. This unique software provides complete power protection for computer system while power failure. With the software users can monitor any UPS status on the same LAN. Furthermore, a UPS can provide security protection for more than one computer on the same LAN at the same time, such as shutting down system in security, saving application data and shutting down the UPS when power fails.

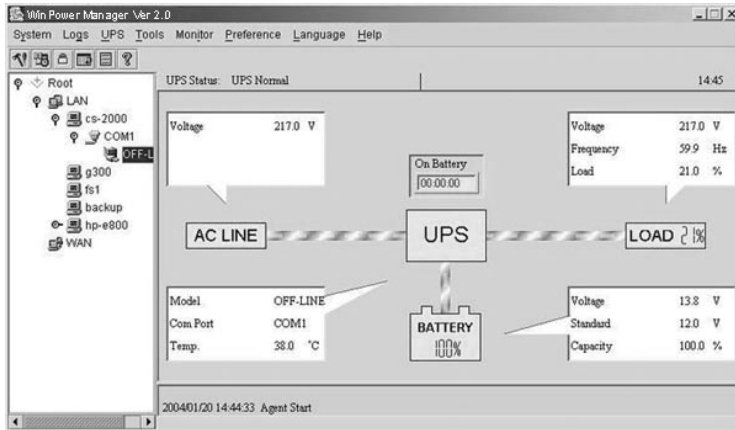

Installation procedure:

1. Go to the website: <http://www.ups-software-download.com/index.htm>
2. Choose the operation system you need and follow the instruction described on the website to download the software.
3. When downloading all required files from the internet, enter the serial No: 511C1-01220-0100-478DF2A to install the software.

When your computer restarts, the Winpower software will appear as a green plug icon located in the system tray, near the clock.